

# VAREE

## Product Image



## Project Data

Project: \_\_\_\_\_  
 Location: \_\_\_\_\_  
 Date: \_\_\_\_\_  
 Remarks: \_\_\_\_\_  
 Approve by: \_\_\_\_\_

Application Type: UNDER WATER SPOTLIGHT  
 Product Name: VAREE Surface Mount  
 Ordering Code: 7414-3-2-867-92  
 Lamp Type: LED  
 Socket: N/A  
 Watt: 18 W(24Vdc)  
 Lumen: 2160 lm  
 Beam: Elliptical H  
 Kelvin: 3000 K

## Dimension

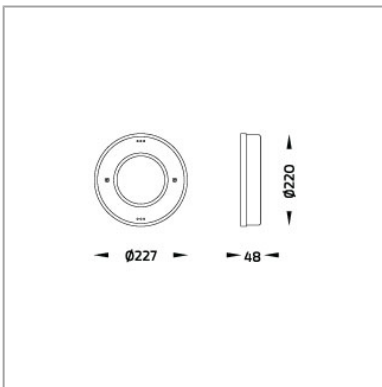

## Light Distribution

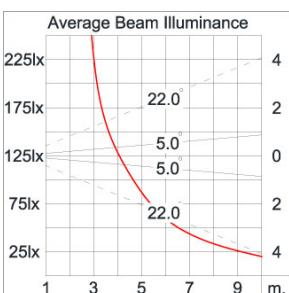
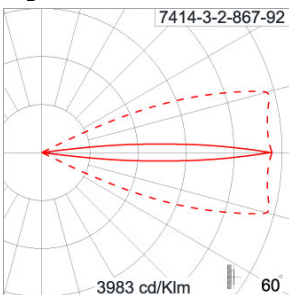

\*Due to the constancy of product development, we reserver the right to alter all specification without prior notice.

# VAREE

## Specification

IEC Standard	IEC 60598-1 General Requirement IEC 60598-2-18 Luminaires for Swimming Pools
Protection	IP68 Class III
IK Rating	Protection against mechanical impact IK05 on body and IK07 optical part.
Luminaires Body Housing	Supreme corrosion proof Under Water grade Stainless Steel. Injected GFR Engineering Polymer body component.
Diffuser	Impact resistant safety tempered glass cover. Able to withstand the temperature up to 250°C.
Lens	Molded PC lens from renowned manufacturers in various light distribution patterns.
Gasket	Post-cured treated silicone gasket. Temperature and weather resistant. Working temperature -40°C to +200°C.
External screws	Marine grade 316 stainless steel screw.
Cable Entry	Cable entry protected by M12 cable gland. To be used with H05RN-F/ H07RN-F cable with 4-7mm. diameter.
LED	High efficiency LED module utilized chips from world renowned manufacturer. Assembled on MCPCB and mounted on to heat conductive material.
Driver	Driver is not included and has to be ordered separately.
Internal wire	Tinned copper conductor with PTFE insulated internal wire. IMQ approved. Working temperature -40°C to +250°C.
Pre-wired cable	Pre-wired with 2x1.0 sqmm. H07RN-F neoprene cable. IMQ approved.
Caution	Installation work has to be carried on according to the enclosed installation manual. To avoid over-heating, this luminaire has to use under water only.

# VAREE

## Accessories



Ordering Code: 0445-0-9-000-00  
LED Constant Voltage Driver  
24Vdc 150W.



Ordering Code: 0446-0-9-000-00  
LED Constant Voltage Driver  
24Vdc 40W.



Ordering Code: 9-0902-00  
IP68 Water Tight Connection  
Device for Through Wiring



Ordering Code: 9-0904-00  
Gel-Filled IP68 Connector for  
Through Wiring Cable  
Diameter 6.5 - 12mm.

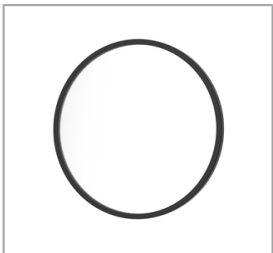

Ordering Code: 0470-0-9-000-00  
Softening Filter

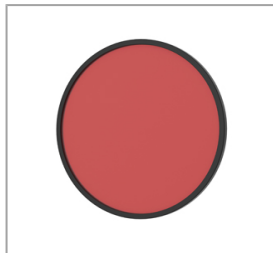

Ordering Code: 0471-0-9-000-81  
Color Filter Red

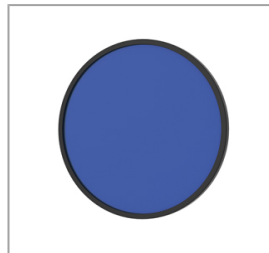

Ordering Code: 0471-0-9-000-83  
Color Filter Blue

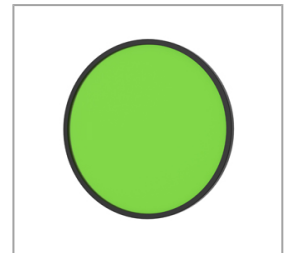

Ordering Code: 0471-0-9-000-84  
Color Filter Green